

# Similar Figures

Each pair of figures is similar. Find the missing side.

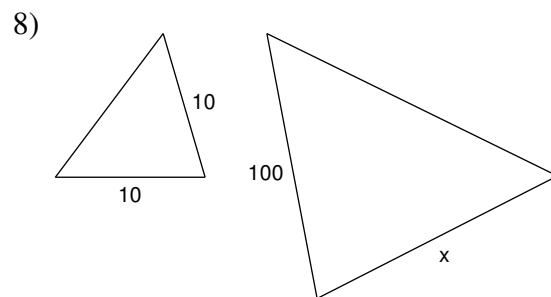

9)

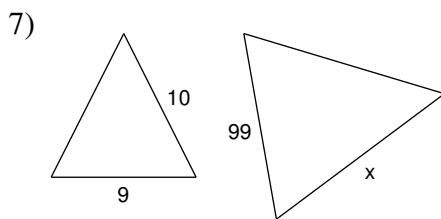
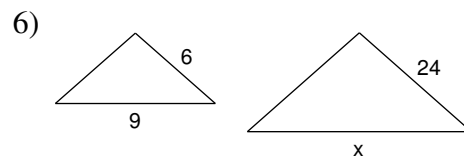
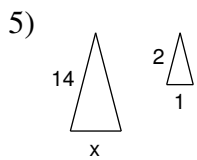
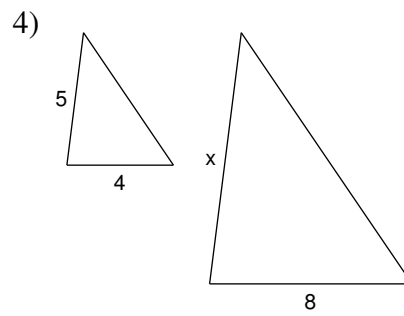
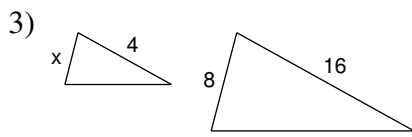
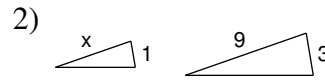
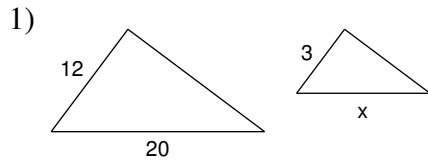
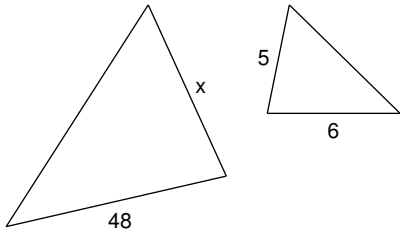

10)

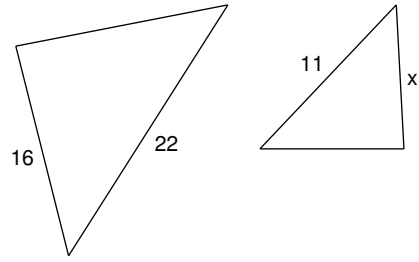

11)

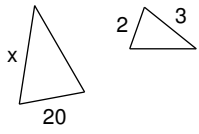

12)

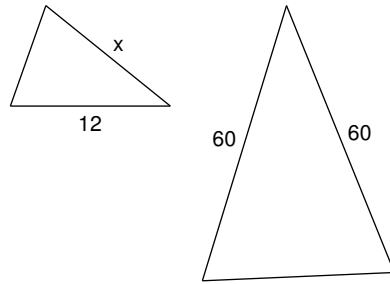

13)

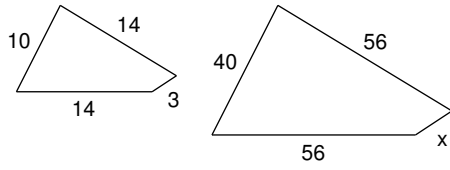

14)

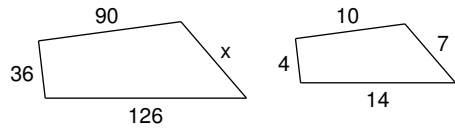

15)

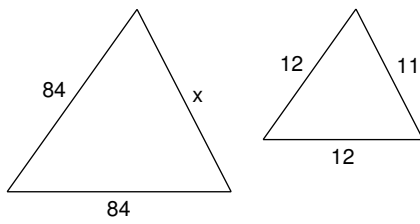

16)

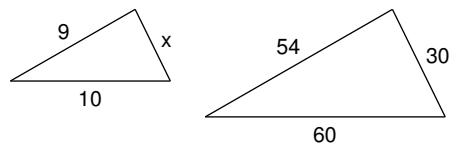

17)

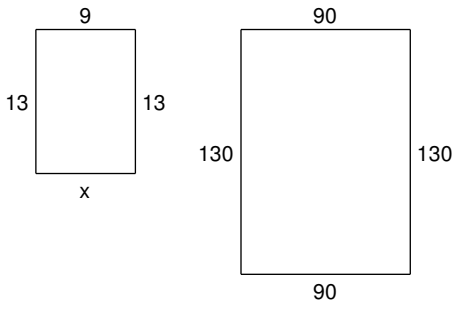

18)

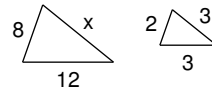

19)

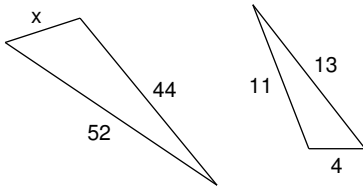

20)

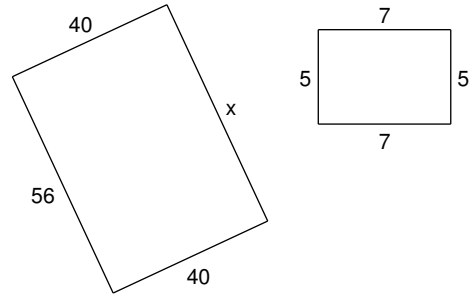

21)

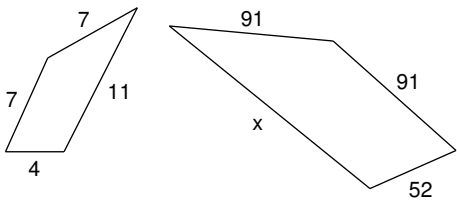

22)

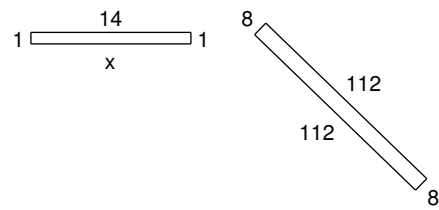

23)

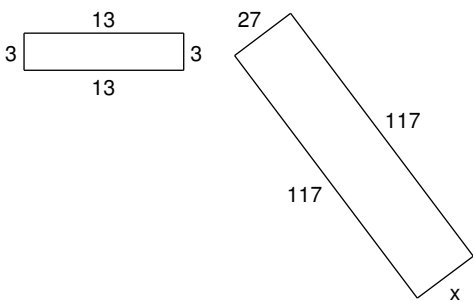

24)

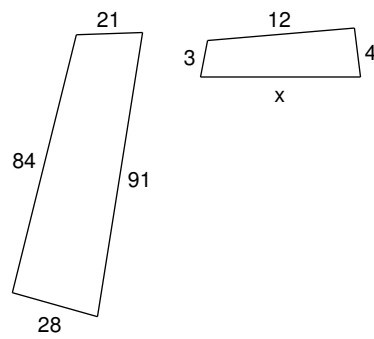

# Similar Figures

Each pair of figures is similar. Find the missing side.

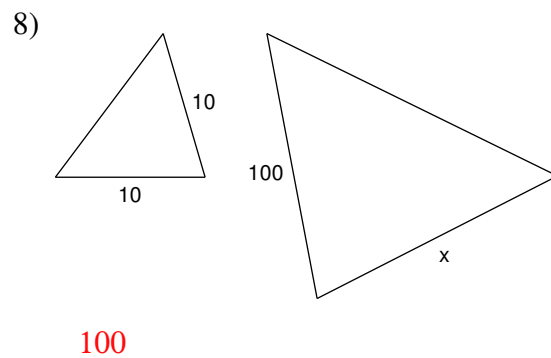
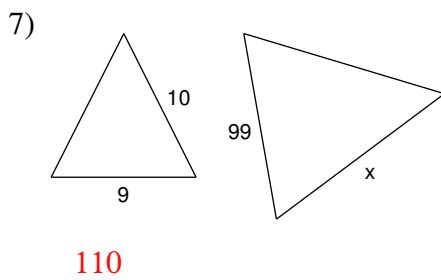
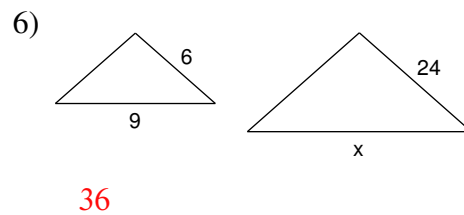
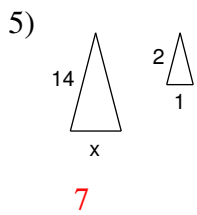
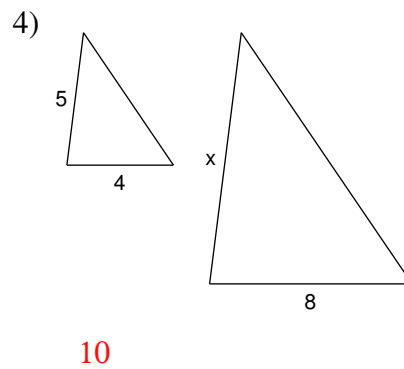
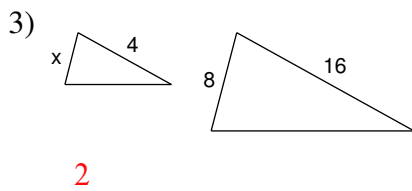
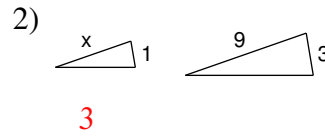
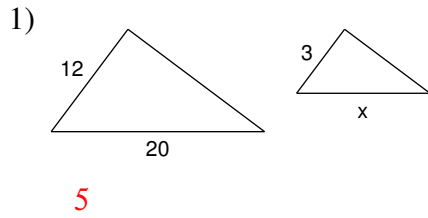

9)

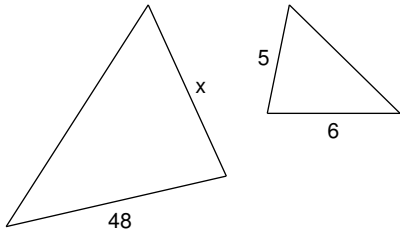

40

10)

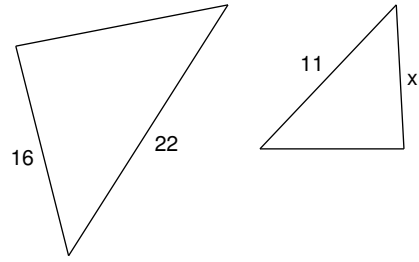

8

11)

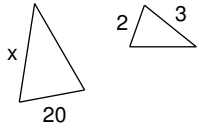

30

12)

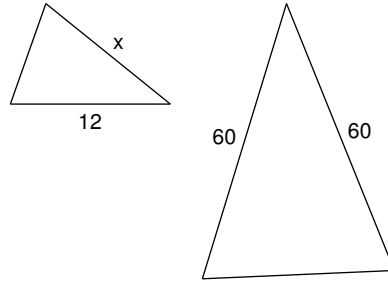

12

13)

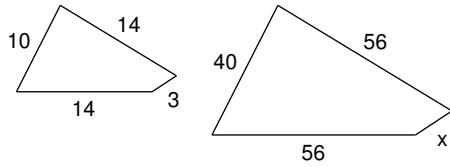

12

14)

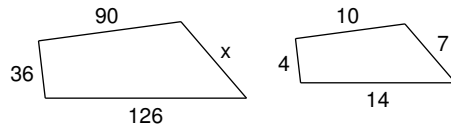

63

15)

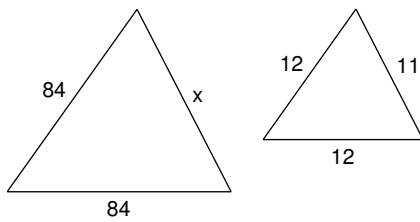

77

16)

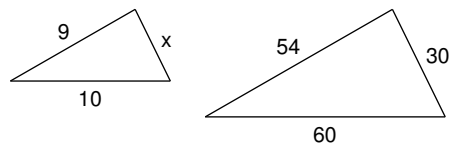

5

17)

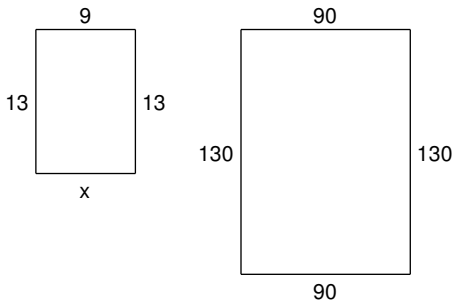

9

18)

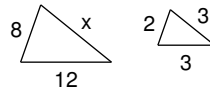

12

19)

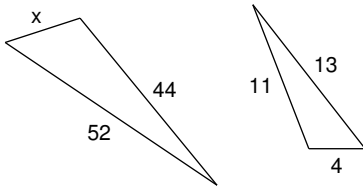

16

20)

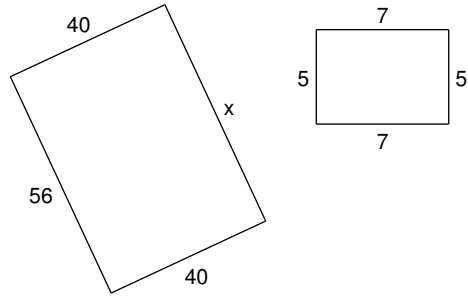

56

21)

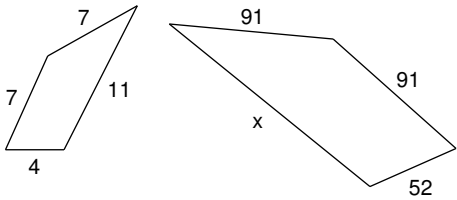

143

22)

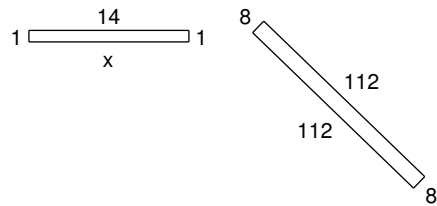

14

23)

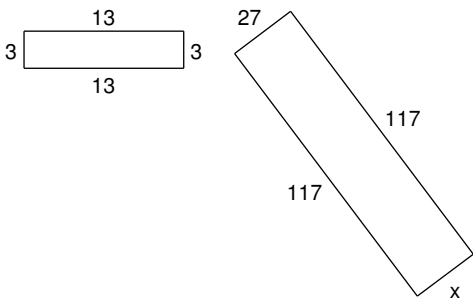

27

24)

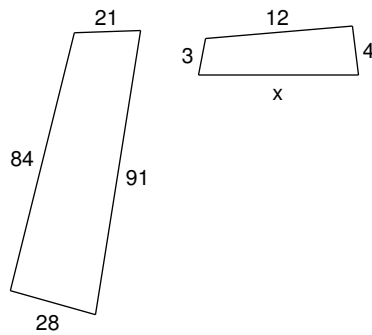

13